

Schubert

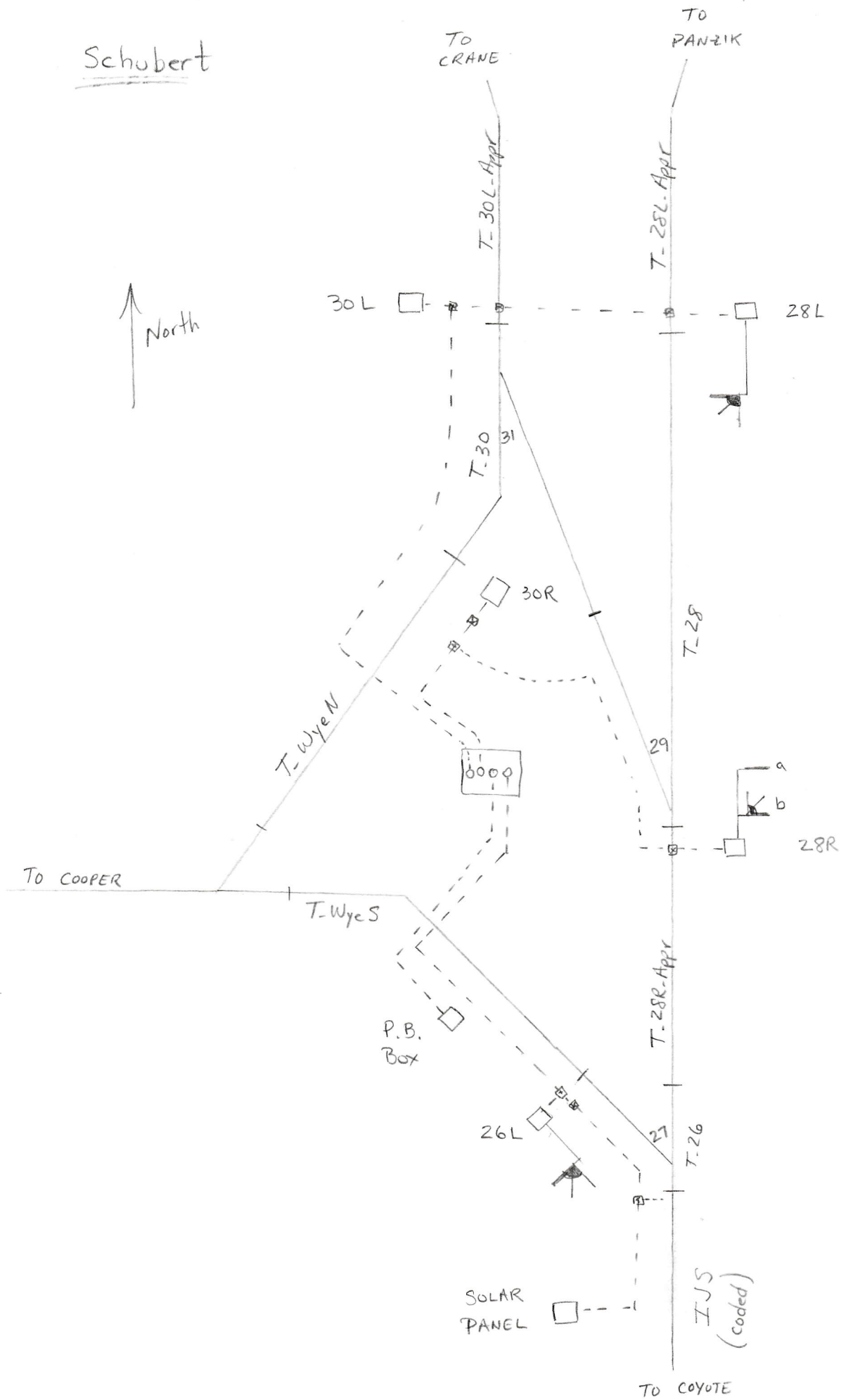

Schubert

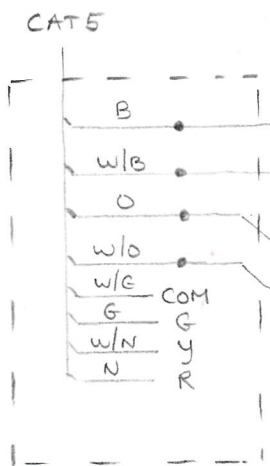
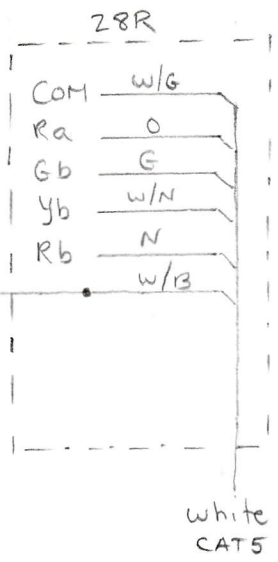
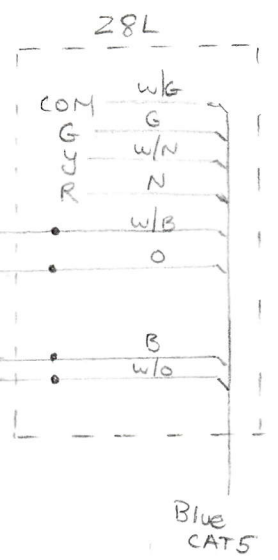
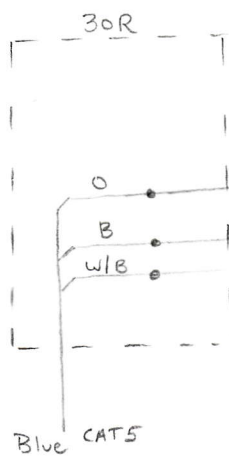
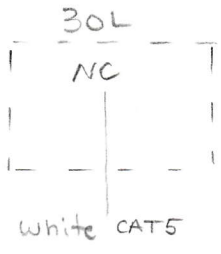

26L

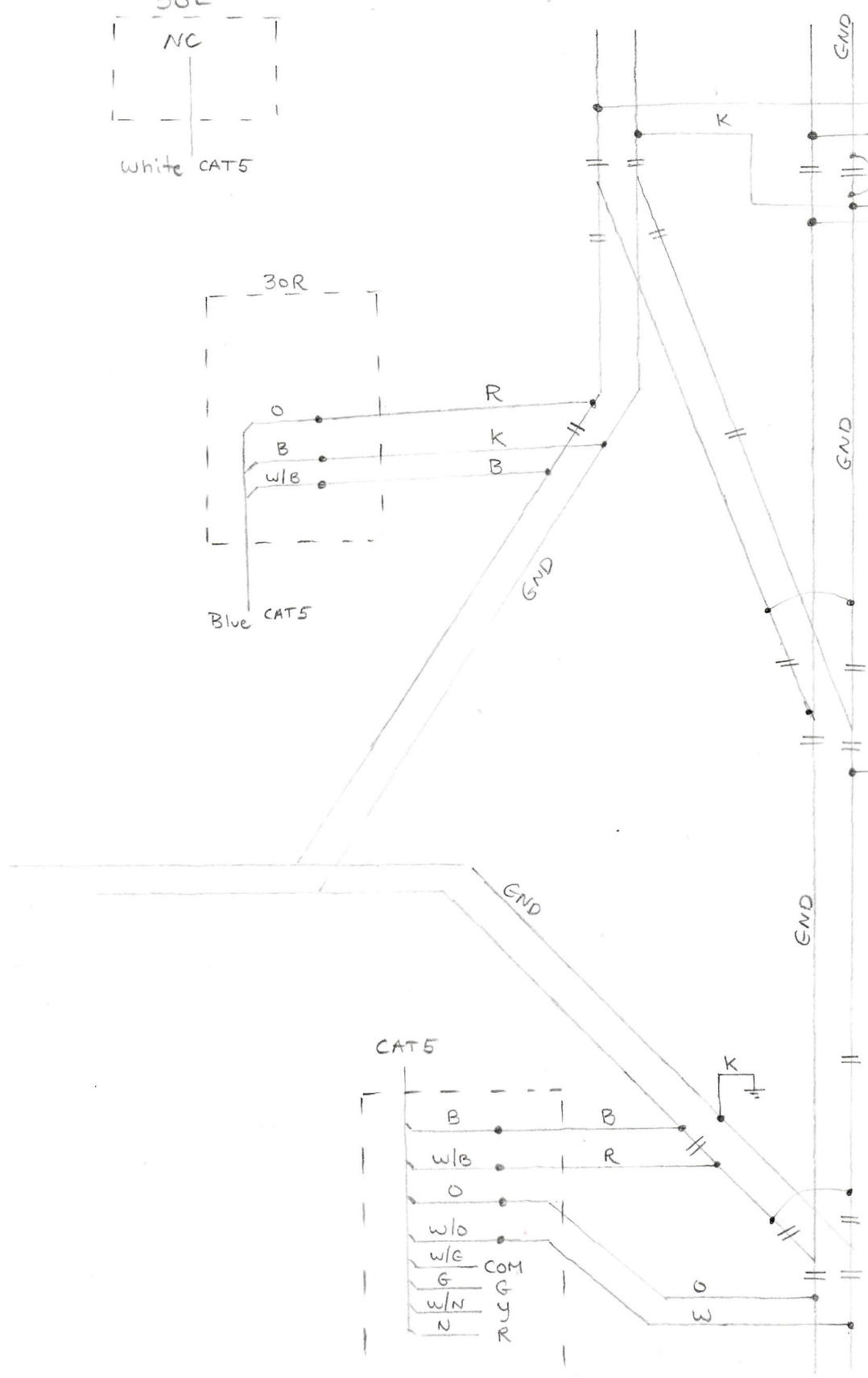

Schubert

Connectors

Program board
with "COOPER.S"

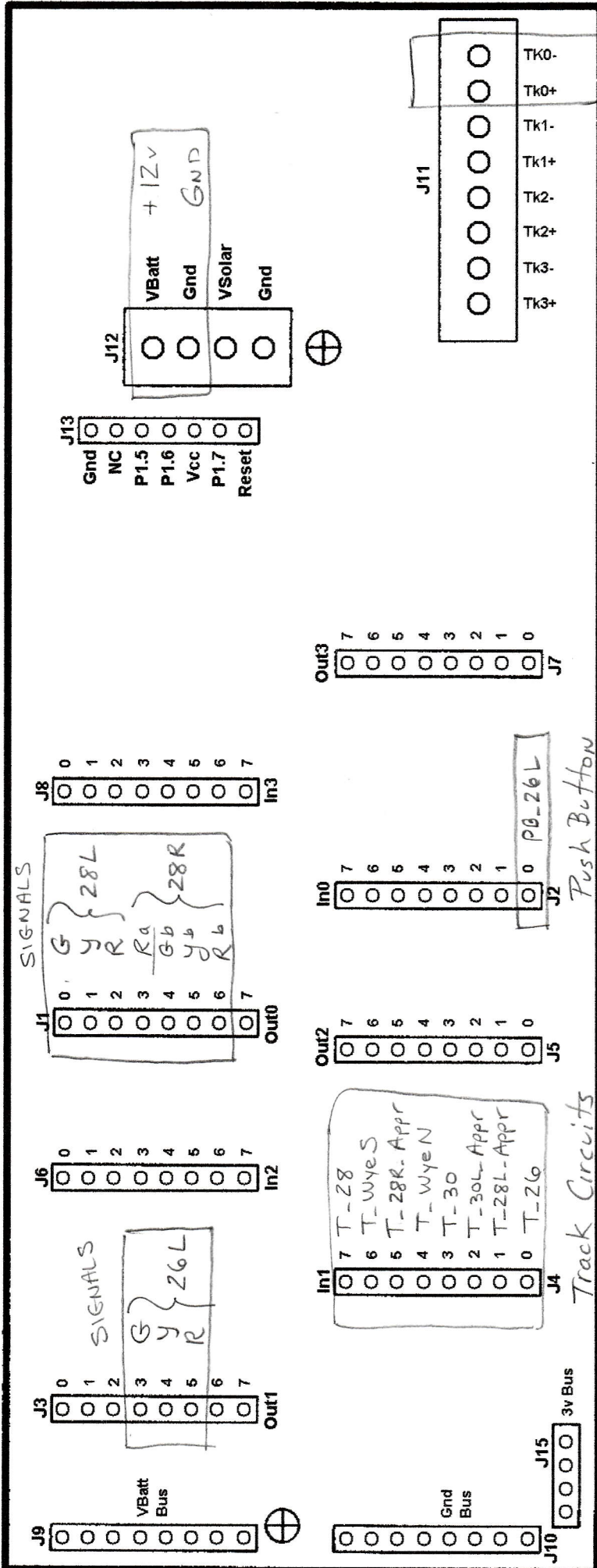

1JS